

# Laminated Dock Bumpers

## B610-18

6" x 10" x 18"

### Features

Tough plies of truck tire material virtually eliminates chipping or abrasion, unlike molded rubber, extruded rubber, conveyor belting or wood plank bumpers. Attractive deep black color enhances a neat, professional architectural look. Manufactured under pressure exceeding 1,500 lbs. to absorb over 80% of impact force.

Anchor bolts are protected by at least 3" of rubber to prevent damage.

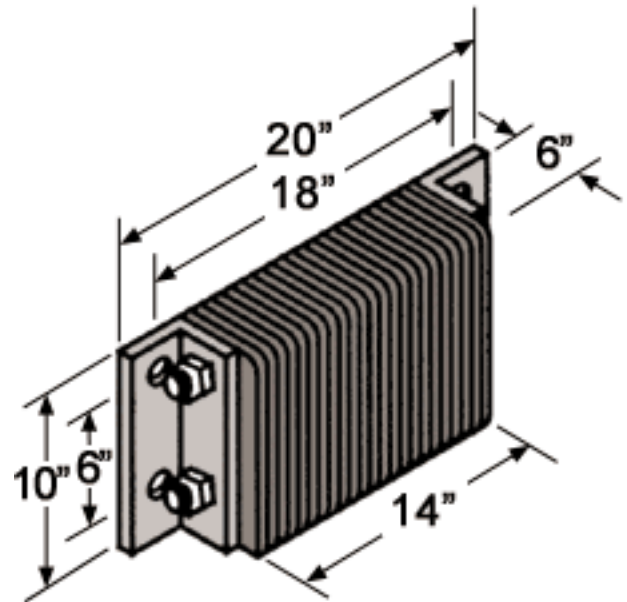

### Installation

Structural mounting angles permit welded installations or provide bolting through steel

### Material/Thickness

Fabric reinforced rubber pads cut from selected recycled truck tires. Rubber pads laminated between structural steel angles and secured with 3/4" steel tie rods.

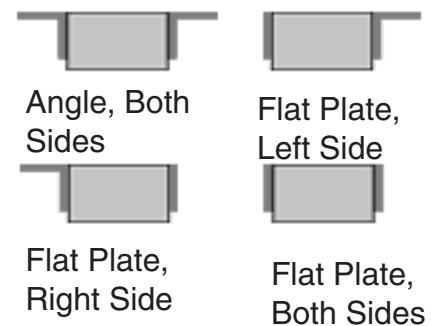

Bumpers may be ordered with angles or flat plates at each end. Use a flat plate for mounting bumper next to a dock leveler, or where the space is too tight to allow the use of angles. Note: When using the flat plate, it is welded to the dock.