

# ROTARY PRODUCTS INC.

## LOADING DOCK EQUIPMENT AND ACCESSORIES

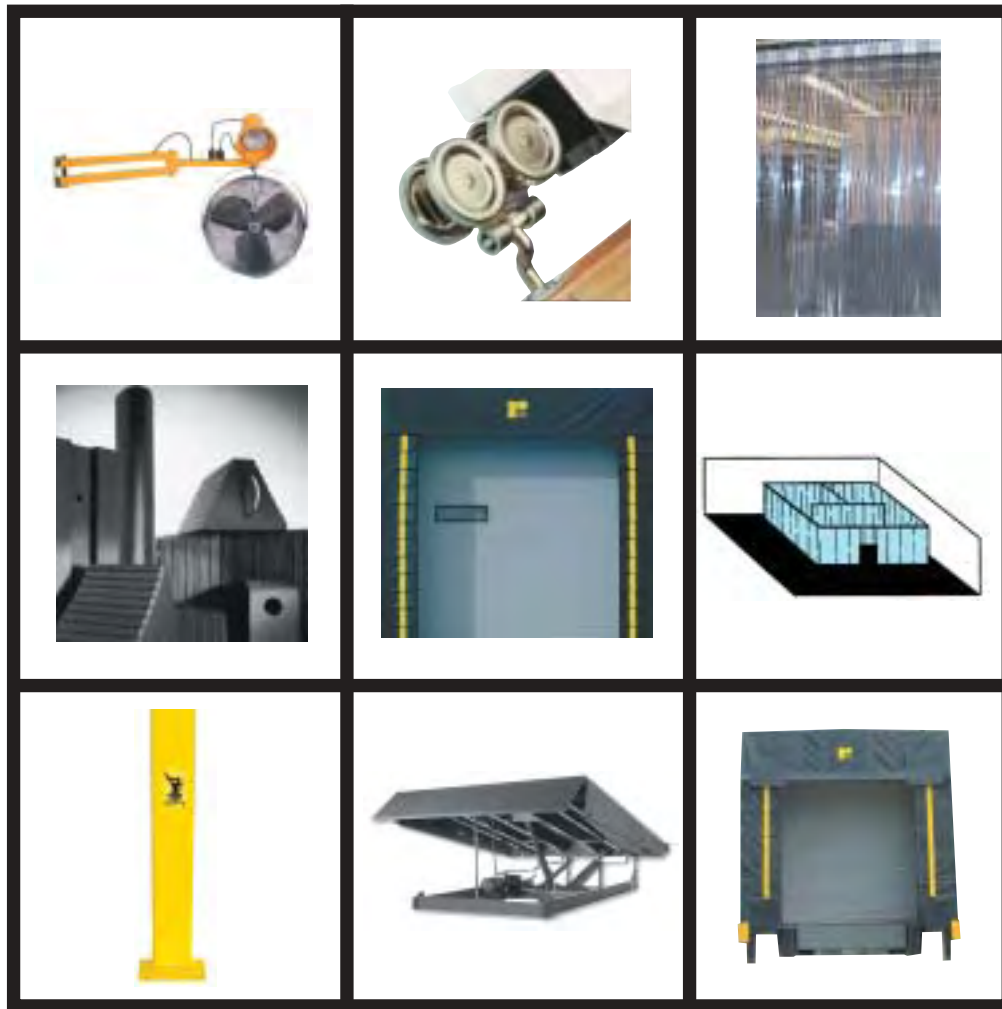

- DOCK SEALS
- DOCK SHELTERS
- DOCK LIGHTS
- DOCK BUMPERS
- SNOW HOODS
- WHEEL CHOCKS
- SLIDING DOOR HARDWARE



- DOCK BOARDS
- TRACK PROTECTORS
- DOCK LEVELERS
- TRUCK RESTRAINTS
- STRIP DOORS
- SAFETY RAIL
- CURTAIN WALLS



# ROTARY PRODUCTS

## Quality Assurance

Is quality gone from all of America's manufactured products? At Rotary Products, we don't think so. ...

The constant pressure to offer the cheapest price on manufactured goods has nearly everyone scrambling to lighten weights, reduce sizes and offer less quality on their products, often without your knowledge. Where does it all end?

Gary and Chris Buechel, owners and operators of RPI, will always strive to maintain the highest quality products available.

*YOUR PRODUCT QUALITY IS ASSURED AT ROTARY PRODUCTS INC.*



### STRIP DOOR MATERIAL

Rotary strip material is from approved manufacturers that produce to  $\pm 5\%$  of specifications. You always get what you ordered. Others skimp on thickness, widths and offer less UV tolerance. Some reduce the plasticizer ingredient. Plasticizers keep the material soft and supple.

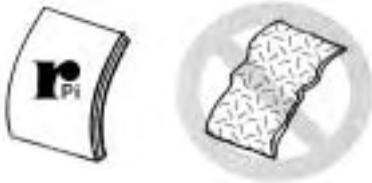

### FABRIC

Rotary's fabric is woven with a stable, vinyl coating bonded to the base fabric for permanency. Others use a less expensive laminated coating which has a tendency to separate from the base fabric.

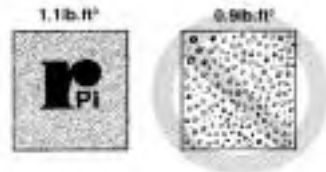

### FOAM

More weight and density give pads longer rebounding life.

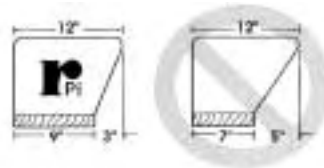

### CONSTRUCTION

Rotary wedge shaped pads have a full 9" wood base (26% more) for a more stable or substantial seal. Other designs project further into the door opening and reduce the available opening width.



### SERVICE

We "stand-behind" what we manufacture and sell! We work for you.

### WORKMANSHIP

Our products are all custom designed and built to order by true experts. Our employees have an average of over 12 years longevity and experience with Rotary.



# TRUCK SHELTERS

- Treated lumber
- Six support trusses on each side
- Steel angles in every corner of construction
- Light transmitting panels in top and sides
- Steel bumper faces safety yellow painted
- Yellow guide stripes to aid drivers



Rotary's full access rigid shelter has light transmitting panels on top and sides. It is made with 2" x 4" and 2" x 6" treated wood construction. Bumpers of heavy steel protect the unit. The header and vertical curtains have blue tempered spring steel stays and are made with heavy vinyl reinforced fabric with heavy fabric overlays on high wear areas.

The standard header curtain height is 3'; the front opening is 7'6" w x 8' h; and the overall size is 11'6" x 11' x a choice of 18", 24", 30", 36" or 42" deep. A minimum of 14" projection beyond the bumpers is recommended.



Rotary Products custom built truck shelters allow full access of docked trailers, unlike a compression seal which may take up some space on the sides due to the pads overlapping the truck opening. This could be critical in the unloading and loading of a trailer. Some merchandise absolutely needs full access to be handled with a forklift, therefore a truck shelter might be the perfect solution. With a dock height of 4', the shelter will accommodate carriers 12' to 13'6" high. Units are also designed to accommodate trailers 8' wide as well as the newer 8'6" wide trailers.



# COMPRESSION SEALS



Rotary Products compression dock seals provide a tight seal between the truck trailer and the loading dock opening.

We know that special dock seal designs are needed to accommodate different slopes and sizes of trailers. That's what makes our seals outlast our competitors! If you want the most clearance for forklift traffic and products, a tight seal for insulation and protection against fumes, dirt, dust, insects and other unwanted matter, then you have come to the right place. Our seals are designed to look good for years to come.

**Rotary seals are custom-designed to fit loading dock applications for companies serviced by ALL types of trucks!**

➤ Specially-designed ventilation holes and vent pockets provide fast air escape and recovery when units are compressed and decompressed by contact with trailer

➤ Special bonding of polyurethane foam to the frame make these seals durable long-lasting performers

## Options

- Belting guards
- Bumper seals
- Wear shields
- Snow hoods
- Fire retardant material
- Custom logos
- Weather stripping

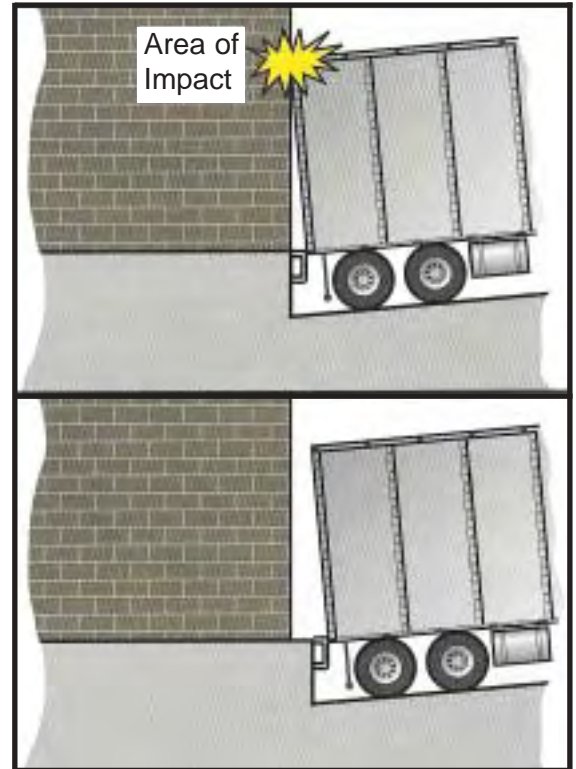

**LOADING DOCK DESIGN IS A KEY FACTOR TO YOUR CHOICE OF SEAL!**

All units are equipped with yellow safety guide stripes to aid drivers in proper alignment of their trailer with the seal.





# COMPRESSION SEAL DESIGNS

## C8 through C21

Header pads with projections from 8" to 21" in 1" increments are available in various combinations of 22 oz. Vinyl; 40 oz. Vinyl; 40 oz. Duroprene; 16 oz. Hypalon; and 40 oz. Hypalon.

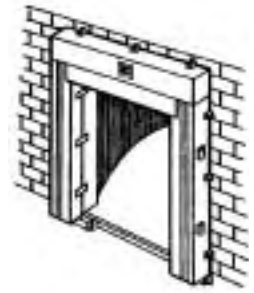

Shown with optional Drop Curtain

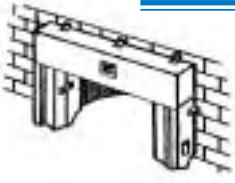

### 18" Header Pad

An 18" high head pad accommodates a greater range of trailer heights than the standard 12" high pad.

## Tapered Compression Seal

Tapered compression seals are designed to match the angle, and form a tight seal with trailers backing up or down sloped drives. Prices are determined by the deepest dimension of the seal. Please consult the factory.

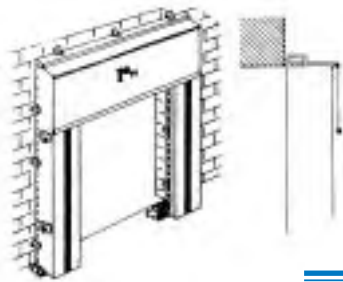
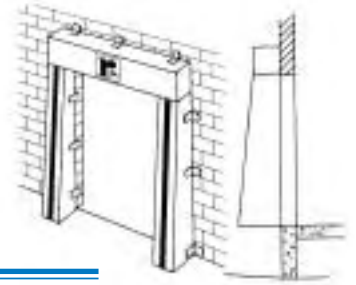

### MC Header

The MC Header is an efficient practical design combined with the highest quality materials to seal extra high door openings. This header design is used to reduce door height openings 10' or higher.

## AC Header

The Adjustable Curtain Header is the recommended design to accommodate and gain full access to various heights of trailers. The simpler construction of a split, roll-up curtain by rope and pulley arrangement is less expensive and more serviceable than the adjustable foam filled header.

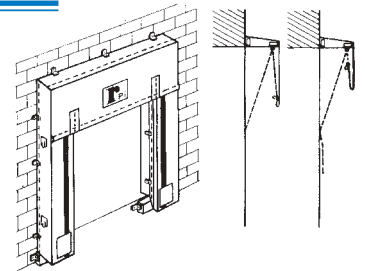

### Extensions

Rotary offers extensions for all compression seals including Z series. Wooden extensions are required when the seal projection is over 21". Made of construction grade painted lumber, extensions are vinyl-covered to match the seal at no extra cost.

## Wedge Shaped Pads

A wedge style pad is available to fit 8' wide doors to reduce the opening without reducing the door size. The base of the pads is 9", wedged to 12" on the face. Custom wedges are available to fit any special situation.

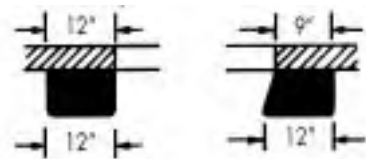

# COMPRESSION SEAL OPTIONS

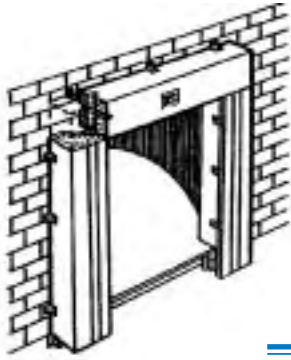

## Z-Series Super Wedge

Rotary's Z-series Super Wedge dock door seal is specially designed to economically seal the openings of 9' or 10' over-sized door widths. A tight, effective weather seal is made to the rear of the trailer by flexing wedge-shaped pads projecting into the opening.



## Fire Resistant Header

All Rotary head pads are available with optional Fire Resistant material. Please consult the factory

## Wear Shields

Wear shields extend the life of the compression seal with layers of material on high impact areas. Flaps move with motion of the truck to reduce cuts, tears and wear from abrasion.

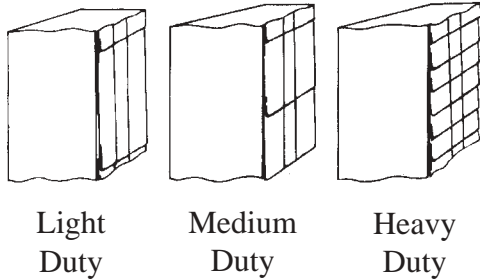

|          | Light Duty | Medium Duty | Heavy Duty |
|----------|------------|-------------|------------|
| Exposure | 16"        | 8"          | 4"         |
| Overlap  | 2"         | 10"         | 5"         |
| Length   | 18"        | 18"         | 9"         |
| Width    | 12"        | 12"         | 12"        |



## SS Snow Hood

A galvanized steel snow hood is recommended for installation over all dock seals. The model SS is designed to protect the top of the seal from damaging rain, snow, and ice. The integral gutter drains to the sides rather than on or in the trailer.

### Model SS weather shields:

- SS-18-18" projection-16 ga material
- SS-24-24" projection-16 ga material
- SS-30-30" projection-14 ga material

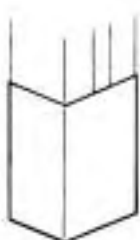

## Belting Guard

Super heavy-duty 1/8" PVC material protects dock seal bottom from damage due to wide freight.

## WS Weather Strip

Rotary's weather strip system economically seals the irregular surface of a metal building. These versatile plastic strips mount above the top member of a compression seal or shelter.

This system really finishes the job!

# GUIDE TO COMPRESSION SEALS

## KEY TO MODEL NUMBERS

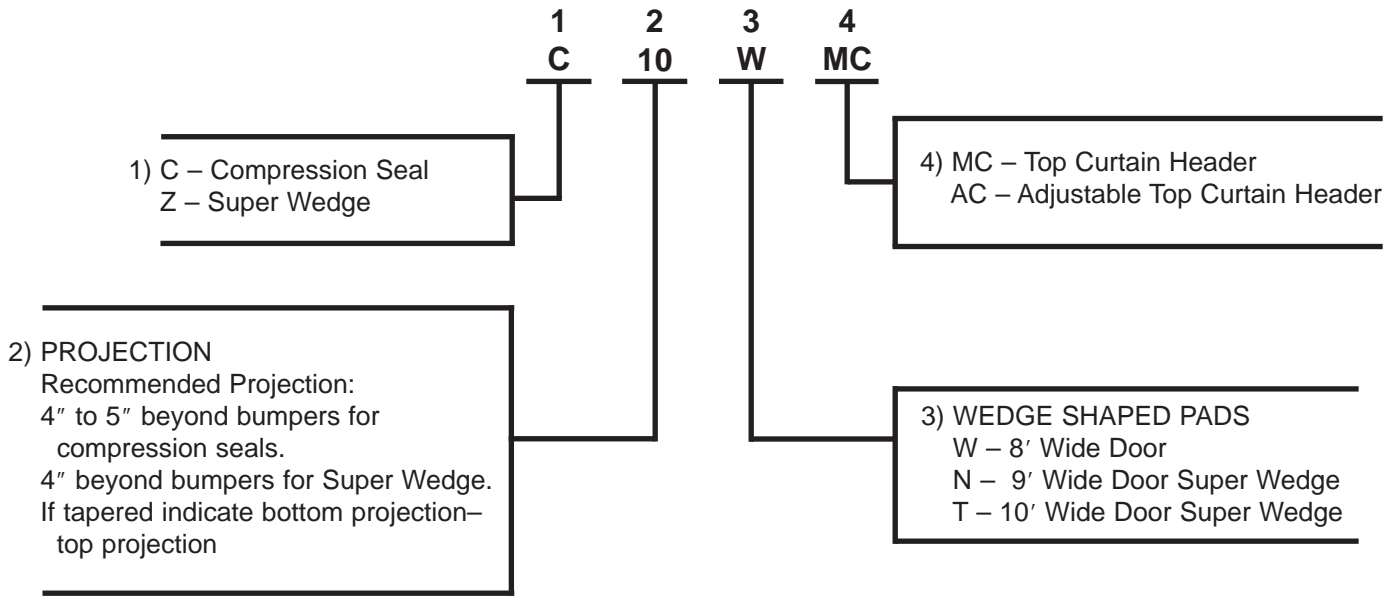

### Recommended for Standard Door Sizes

| Door        | Model            | Number  | Vertical Length | Common Options Used  |
|-------------|------------------|---------|-----------------|----------------------|
| 8'W x 8'H   | Compression Seal | C10W    | 8'              | 18" Header           |
| 8'W x 9'H   | Compression Seal | C10W    | 9'              | 12" Drop Curtain     |
| 8'W x 10'H  | Compression Seal | C10W-MC | 10'             | Curtain Style Header |
| 9'W x 8'H   | Super Wedge      | Z10N    | 8'              | 18" Header           |
| 9'W x 9'H   | Super Wedge      | Z10N    | 9'              | 12" Drop Curtain     |
| 9'W x 10'H  | Super Wedge      | Z10N-MC | 10'             | Curtain Style Header |
| 10'W x 8'H  | Super Wedge      | Z10T    | 8'              | 18" Header           |
| 10'W x 9'H  | Super Wedge      | Z10T    | 9'              | 12" Drop Curtain     |
| 10'W x 10'H | Super Wedge      | Z10T-MC | 10'             | Curtain Style Header |

Recommendations based on 46" to 50" dock height

**NOTE:** 10" projection on above models is arbitrary. Use bumper projection plus 4" to 5"

## DOCK BUMPERS & WHEEL CHOCKS

### Dock Bumpers

Protect your docks and cargo from damage with dock bumpers.



See additional brochure for models available.

- Easily attached
- Absorb shock and impact
- Eliminate dock repair
- Extremely durable

### Wheel Chocks

Resistant to sun, moisture, salt, oil and meets OSHA requirements.

Designed to provide maximum gripping power on practically any surface - wet or dry!



**Prevent Accidents!**

See additional brochure for models available.

# DOCK LEVELERS

20,000 lb. & 30,000 lb. Dynamic Capacity  
66" and 72" Deck Widths.



Complete line of Edge Of Dock Levelers including, Lever activated and Hydraulic styles.



## Edge of Dock Levelers

- 1 Year standard warranty
- 55,000 lb. minimum yield safety treadplate
- Economical and easy to install

### P1000 Series



- 55,000 lb. minimum yield steel tread plate
- Structural "C" channel deck support beams
- Dock bumpers are included
- Conveniently-located pull chain provides easy activation of the deck and lip.
- Direct extension spring provides easy walk down, no moving parts to wear out
- Standard working range toe guards and grease fittings on lip hinge
- Safety legs automatically provide multiple below-dock safety points

### EHP Series



- 55,000 lb. minimum yield steel tread plate on deck and lip
- Structural "C" Channel deck supports are fully welded to full width header plate
- Push button electric hydraulic actuation
- In-line safety stop prevents sudden fall of deck
- Standard working range toe guards
- Grease fittings on lip hinge
- Molded bumpers
- 18" lip projection-12" beyond bumpers
- Deck to tilt 4" from side to side to compensate for un-level trucks

### HP Series



- 55,000 lb. minimum yield steel tread plate
- Structural "C" channel support beams
- 20,000-45,000 lb. Capacities
- Automatic lip extension
- Automatic return to stored position when truck leaves
- In-line safety stop prevents sudden fall of deck
- Full operating range toe guards and grease fittings on lip hinge
- 5 year warranty on all structural members and cylinders



### Safety Lights and Signs

Prevent accidents at the loading dock. Lights and signs are used to aid truck drivers with dock safety procedures.



### Automatic Truck Restraint

Low-profile with 12" to 30" operating range. Restrains a force of over 50,000 lbs. Automatic push button control for easy operation.



### Mechanical Truck Restraint

Low-profile economical restraint that bolts to dock face and ground. Restraining force of over 50,000 lbs. Unit has self cleaning spring and hook assembly.



# LEVELER ACCESSORIES & TRACK GUARDS

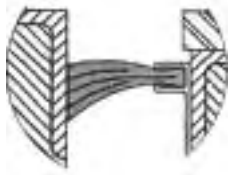

Leveler sealing kits are necessary for keeping cold air and insects out of your warehouse. These inexpensive kits are easy to install and durable enough to last for years!

Tough industrial strength brush seals can be mechanically mounted, or welded on to your surface.

**Finish it right!  
Complete the seal!**

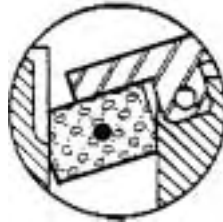

Rear seal is designed with super foam construction for lifetime use.

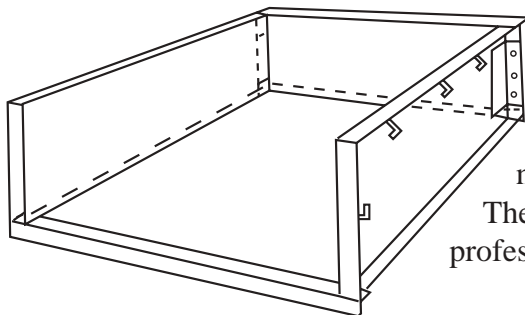

## PIT LEVELER EASY PAN

The Easy Pan pit leveler forming kit lives up to its name. This unit is set down into an oversized rough pit. The concrete is poured around the pan and the result is a professional, accurate preparation for leveler installation.

## DOOR TRACK PROTECTORS

Standing Guard Track Protectors are designed to eliminate costly damage to overhead door tracks that can be caused by forklifts, cars, trucks, and negligent acts. Doors with damaged tracks can be costly by inhibiting operation of the doors and interfering with the loading and unloading of products and/or equipment. Sets can be shipped via UPS.

Easy Installation—Large Savings for Minimal Investment—Reduces Insurance Claims

- **40" High**
- **6" fabricated channel made from 1/4" thick A-36 hot roll pickled and oiled steel**
- **Welded to a 1/4" thick 6" x 10" plate made from the same material**
- **Plate has (4) 5/8" diameter holes punched 3/4" from edges**
- **All edges are de-burred prior to being painted using Sherwin Williams safety yellow epoxy paint**
- **(8) 1/2" x 4-1/4" wedge anchors are included with each set**

**Built for the  
Protection of  
Overhead Door  
Tracks!**

**Designed to fit any size  
or shape of track!**



# DOCK LIGHTING & GUARD RAILS

## NEW & IMPROVED!

Need a heavy duty light? Ask about our triple strut dock arm that can be used with one of (4) lights and an optional fan!



## OPTIONAL FAN

- 18" high velocity circulator, with 3 speed, 1/8HP, 115V, 1 phase permanently lubricated, totally enclosed, PSC motor
- Modular fan plugs into electrical outlet on arm
- Chrome plated metal guards
- Aluminum blades



**24" / 40" / 60" ARMS**  
That Can Be Used With  
One of (4) Light Heads

Light sources include incandescent, quartz halogen, high pressure sodium and the NEW metal halide.



For more information on RPI's dock lights please see additional brochure.



Standard Duty Arm

- The mounting arm has 5' long, 18/3 SJTW conductor cord with a NEMA 5/15 ground plug
- 1-1/2" square, 14 gauge, steel tubing
- 3" x 5" x 3/16" mounting plate attaches with (4) 3/8" bolts



Heavy Duty Triple Strut Arm

## GUARD RAILING



SAF-T-Rail is the premium rail on the market today, offering strong protection for mezzanines, in-plant offices, conveyors, water mains, valuable equipment and personnel.

Rotary Products offers a complete line of accident intervention systems. If you or your company need people protection, property protection and/or code compliance, you've come to the right place.

- 10,000 lb. load at 4 mph rating
- Easy to install with anchors and hardware included
- Lift out rail available
- Rail available in 4', 5', 6', 7', 8', 9', and 10' lengths. Single rail columns are 18" high, double and triple rail columns are 42" high

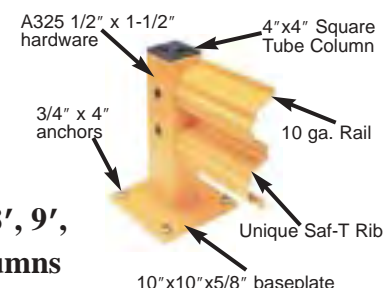

For more information please see additional brochure.

# SLIDING DOOR HARDWARE

**TAB-LOC lets one person assemble a steel door frame in 10 minutes.**



**Save time  
and money!  
Order a kit  
and get it all!**

## TAB-LOC

The All Steel Sliding Door Frame is available with 1-7/8" thick laterals. The 1-7/8" door is fabricated entirely from 16 gauge galvanized steel with self-flashing verticals having a durable, baked-on white finish. It has prefinished, self-flashing verticals. It's lighter than wood, yet is much stronger to last a lifetime. It won't crack, warp, rot, swell or stick. See additional brochure.

The secret is in National's exclusive, patented locking tabs. These built-in fasteners are pre-punched into the frame members. Just bend the tabs down into matching slots for a square, tight, permanent steel door frame. Unlike any other door frame, you don't even need a level area for assembly. Once you're familiar with TAB-LOC, 10 minutes is all it takes to get a frame ready to attach the siding. In fact, the door can be completed and hung in under an hour to previously installed rail. See additional brochure.

## EASY-FRAME

Steel Verticals available for 1-1/2" and 3-1/2" wood laterals. The 16 gauge galvanized steel verticals are pre-punched for nails and are self-flashing with a durable, baked-on white finish. Wood laterals simply slide into the Easy-Frame steel verticals and door siding slides into the flashing channel eliminating separate flashing. See additional brochure.

Supporting a 600 lb. door, TrackMaster hangers by National have been torture tested without failure through over 10,000 cycles of opening and closing a door! That's opening and closing the door once a day for 30 years! Please see additional brochure.

- **Easy to install**
- **Easy to operate**
- **Self Cleaning**



**TrackMaster by National is interchangeable with other brands of round rail and hangers!**

## SLIDING DOOR HARDWARE

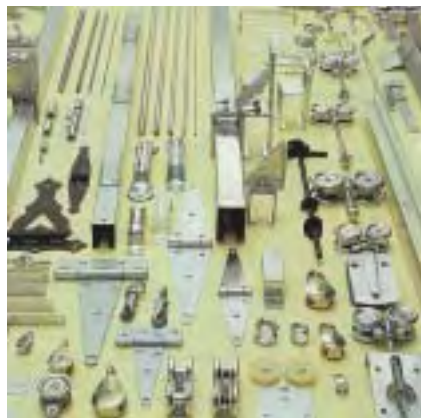

Rotary Products offers sliding door kits for doors weighing up to 1,000 lbs. Imagine being able to get all the pieces at one time! No running back to the hardware store, no "out of stock" signs, one order and it's packed and shipped! We want to make it easy on you! Please see additional brochure.

- **BOX RAILS**
- **FLEXIBLE BOX HANGERS**
- **RIGID BOX HANGERS**
- **ROUND RAIL AND BRACKETS**
- **ROUND HANGERS • FLASHING**
- **SPECIALTY RAILS AND ACCESSORIES**
- **AND MORE...**

# STRIP DOORS & PVC MATERIAL



Rotary Products Inc. offers PVC strip material up to 48" wide, in a variety of weights and colors. Please see additional brochure.

## STRIP DOORS

Transparent Strip Doors are used in high traffic areas to effectively cut energy costs, save time, and promote safety. A series of flexible plastic strips permits rapid unrestricted passage, yet isolates noise, fumes, and loss of conditioned air.

- > **Exceptional Clarity**
- > **Full Spec Material**
- > **Made in the USA**
- > **Save Energy**
- > **Isolate Noise**
- > **Keep Fumes Out!**
- > **Keep Conditioned Air In**

Our material is non-yellowing and available in multiple weights and widths. A special tinted material is available to enclose welding areas. For food processors, cold storage and freezer doors, a non-toxic USDA accepted polar material should be specified.

**SAVE TIME AND HAVE  
YOUR DOOR--  
FACTORY ASSEMBLED!**

- > **Smooth PVC strips**
- > **Ribbed PVC strips**
- > **Anti-Static PVC strips**
- > **Weld PVC strips**
- > **USDA PVC strips**

**Material is available  
in Bulk Rolls or  
custom sizes!**

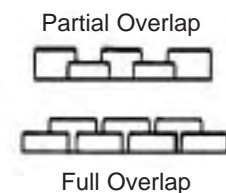

Strip overlap and width can be an important decision to make if you want an efficient door! Door height, weather conditions, and traffic should be a factor in your decision.

**Added bonus —  
Get orange end pieces  
at no extra cost!**

| Typical Strip Door Applications  | Specifications |       |            |
|--|----------------|-------|------------|
|  | Thickness      | Width | Overlap    |
| Personnel Door<br>For interior walk-through doors up to 7' height.<br>Lightweight and inexpensive.                                   | .040"<br>.060" | 6"    | 2"         |
| For interior doors to 8' height.<br>9' height with full lap<br>Not recommended for exterior opening.                                 | .080"          | 8"    | 2" or Full |
| For interior doors up to 10' height.<br>Not recommended for exterior opening.  | .080"          | 12"   | 4" or Full |
| For minimum protection for exterior openings.<br>Maximum 12' height.   | .120"          | 12"   | 4"         |
| For better protection for exterior openings<br>to maximum 14' height. Also for better<br>noise control.                              | .120"          | 12"   | Full       |
| For doors with heavy vehicular traffic.<br>Somewhat difficult for personnel traffic.   | .160"          | 16"   | 4" or 6"   |
| For exterior doors with constant heavy-duty<br>equipment. Best for sound control. Not<br>recommended for constant personnel traffic. | .160"          | 16"   | Full       |



# STRIP DOOR HARDWARE

## USM

If you need a strip door that is a safe and consistent performer then you need our **Universal Steel Mount hardware system!**

Over the years manufacturers have come up with different ways to build PVC strip doors, but the efficiency, safety, and performance of the doors has not been addressed! Our hardware is Industrial Grade Steel, strong enough to last a lifetime, rounded mount covers give PVC strips a longer life, and the ease of installing make it the #1 choice in today's market. Safety and time is money in your pocket! Don't take a chance, order Today!

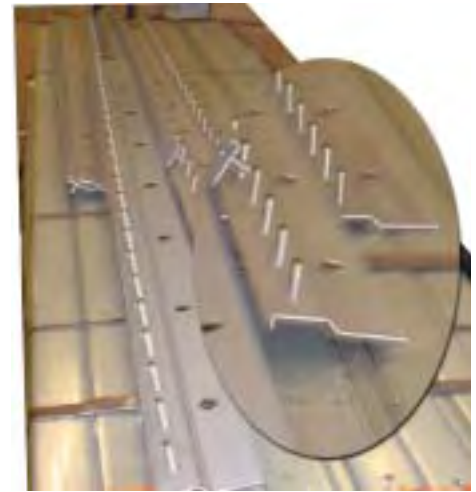

Universal Steel Mount can be mounted between jambs or on the face of your wall.

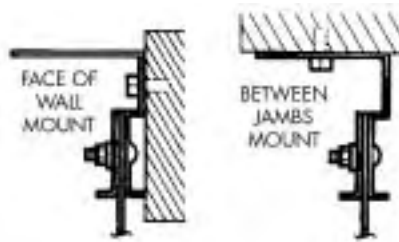
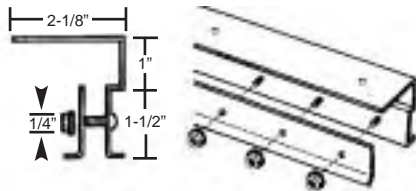

Cover plate and USM have rounded edges to keep strips from breaking. 1/4" x 1" studs are permanently fixed on 2" centers.

## ROLLING STYLE MOUNT

Rolling Style doorways can be the convenient system for some warehouses and buildings. For a rolling door remember that wall space is needed for the door to roll across while in the open position.

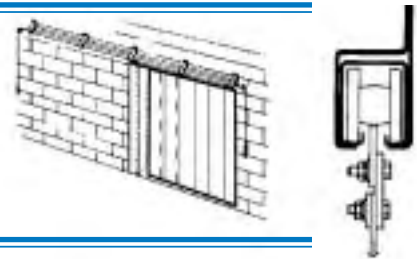

## FRAME-IN-MOUNT

Frame-in-mounting styles are designed with PVC returns on both ends to seal edges tight! This system allows the strip door to free-span door tracks. It will not inhibit door operation and strip door is inside building when garage door is closed.

## REMOVABLE MOUNT

Rotary's exclusive removable Mount is ideal for allowing your strip door to be used seasonally. Sometimes a strip door needs to be removed and stored and then re-hung at a later date. With the removable mounting system, the hardware needs to be attached just once to your building's surface, and then the Universal Steel Mount can be taken down over and over again without drilling new holes.

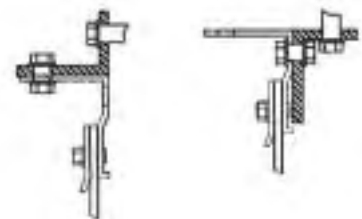

Storage can present a problem for PVC strips. Each strip is concaved to make a perfect seal so it's important that if you re-hang a strip door that you put the strips back the way they are designed to work properly. Our Strip Door Storage rack can help. Just take down the Universal hardware with the strips already attached, and hang it up! Save money, time, and space by ordering an RPI Strip Door Storage Rack! Units hold up to three 6' sections.

# CURTAIN WALLS

## Curtain Walls!

**A simple, easy, and inexpensive method of forming portable, isolated areas for privacy, cleanliness, safety, environmental control, etc.**

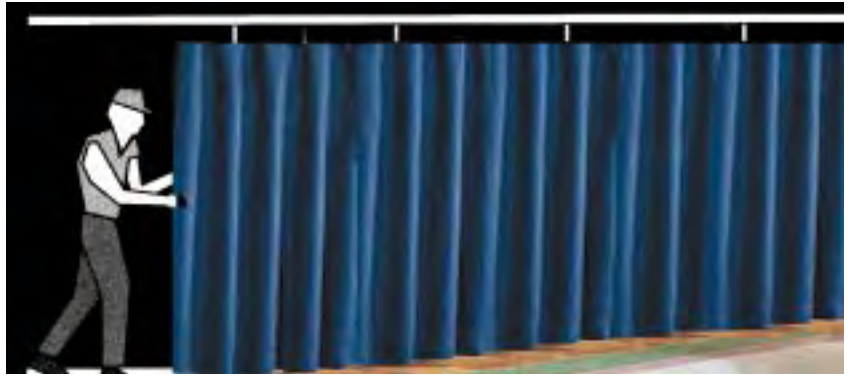

It's up to you! If you need a temporary wall for any number of reasons, the Rotary Products Custom Curtain Wall system can fill your needs. Ideal for manufacturing facilities, warehouses, offices, schools, institutions, wherever control over any area is needed. Rotary Products Custom Curtain Walls are easy to install and can be set up by your own personnel without using special tools or skills.

They can be designed to suspend from the ceiling or roof bracing structure, mount to walls, or hang from a free standing support system. Curtain material can be stretched over panels or hung from track that allows them to be rolled out of the way when not in use.

Our selection of the finest material includes translucent and opaque fire retardant vinyls and clear PVC. Clear plastic windows, chain weighted bottoms, even walk through strip doors are available.

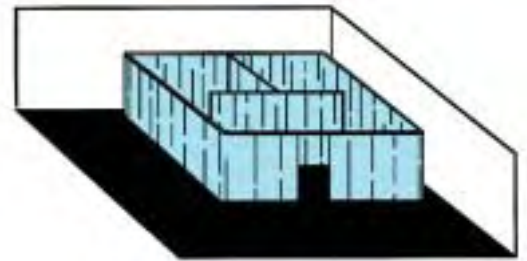

### Full Enclosures

Rotary Custom Curtain walls create new, useable areas out of larger, unmanageable spaces making them more functional. Any size of work area can be created with movable or retractable panels that can be added or deleted at any time.

**A wide variety of hardware pieces can be used to provide any shape needed to enclose a space.**

**Remember, your imagination and needs are the only limits in designing a Rotary Custom Curtain Wall.**

Let our RPI representative recommend the best design and materials to suit your application.

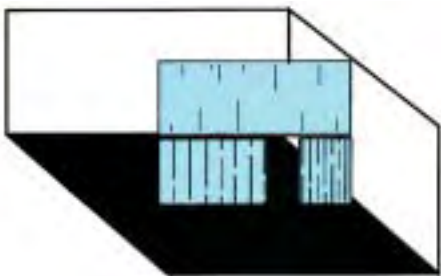

### Partitions

Section off large buildings like warehouses and factories for environmental control, safety, or noise control. Permanent top panels for high ceilings with free standing sliding panels below allow usage and accessibility.



### Isolated Areas

Any size of small work area can be created within a larger area quickly and easily. Sections can be added or deleted at any time with movable panels. Curtains can be rolled back or removed when not needed.

# CURTAIN WALL HARDWARE

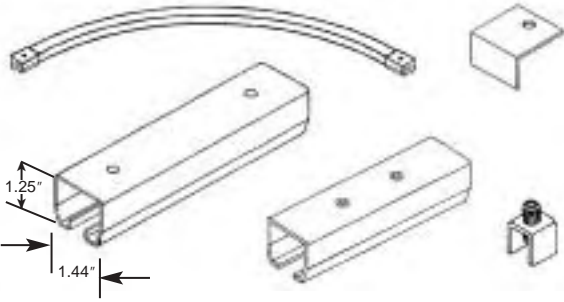

## TRACK AND ACCESSORIES

The basis of the Rotary Custom Curtain Wall is its unique hardware system. There are three basic elements to the system, and a wide variety of different methods of mounting these basic elements. The basic elements include:

- Straight and curved track sections
- Track splices, track joiners, and end stops
- Track trolleys that hold the curtain material and move inside the track

Trolley systems are available with either nylon wheels or steel ball bearing wheels. The nylon wheels are designed for systems that use light curtain materials; the steel ball bearing wheels are the better system for heavier curtains. The wheel design allows the curtain to roll easily and close fully. The trolleys are available in a variety of designs with different wheel configurations, curtain hanger hooks, with or without bumper protectors, or designs that allow a curtain to overlap and trolleys to be pulled by a rope to prevent damage to the curtain material in certain applications.

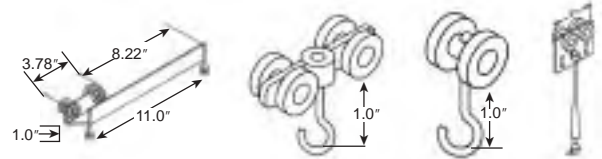

## TROLLEY SYSTEMS

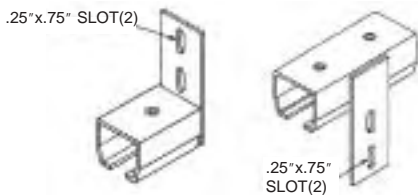

## WALL MOUNTING HARDWARE

Wall mounting hardware is used to mount track system to adjacent walls, or where the track ends into a wall. The mounting brackets are either above or below the mount for choice of mounting close to ceiling or closer to door height. There are brackets, splices and end mounts.

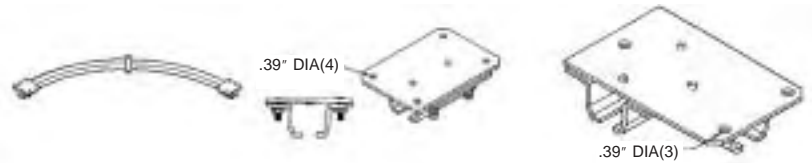

## CEILING SUPPORTED HARDWARE

Ceiling supports are designed to have the entire custom curtain wall system attached to the ceiling in offices and other low ceiling areas. The hardware is designed so that track can be inserted before or after the hardware is attached to the ceiling. There are no screws or nuts protruding above the mounting plates. No spacers or clearance holes are needed to work with the hardware. The mounting plates have stud ends that are used to lock the track to the support hardware. Curved track, splices, brackets, right angle and three-way intersection brackets are all available with the ceiling support plates.

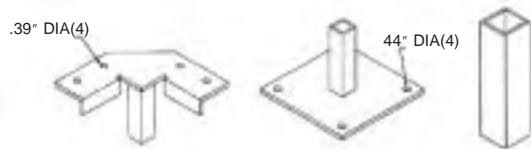

## FLOOR SUPPORT HARDWARE

This hardware is designed to allow you to support parts of or the entire curtain wall system from the floor. The support columns are 1-1/4" square 12 gauge steel tubes that are in 6', 7', 8', 9' or 10' lengths. Base plates for the support tubes are 6" squares that are made from 1/4" thick steel plates. Floor support curved track, splices, brackets, right angle, three-way brackets, and corner brackets are available.

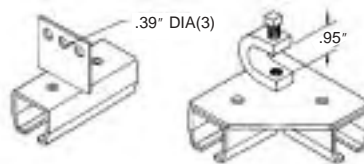

## BEAM FLANGE SUPPORT HARDWARE

The beam flange support hardware is designed to allow attachment to edges of roof trusses, beams or channels with edge clamps and set screws. The edge clamps can be rotated for alignment to the support structure. Brackets, splices, right angle and three-way brackets are available with the beam flange clamp system.

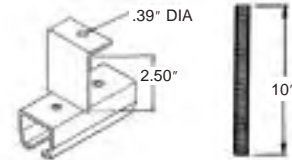

## THREADED ROD SUPPORT HARDWARE

The threaded rod support hardware is designed for use when there are no easily accessible structures near the area you want to hang the track. The rod can be mounted to any structure near the ceiling and significantly above the track system. The rods are available in 10' long sections and can be joined together with coupling nuts. Edge clamps like those used in the flange clamp system can be used to clamp rods to ceiling beams, trusses, etc. Splices, brackets, right angle and three-way brackets are available.

## DOUBLE TRACK HARDWARE

Support hardware for double track systems is available in all of the different styles listed on this page. Contact the factory if you need support hardware for double tracks.





We estimate that in the field, 60 to 70% of the dock seal applications are misapplied in one way or another. This is due to a lack of understanding and information. When you call Rotary Products, you won't speak to voice mail, nor will you speak to an order taker. You will speak to one of two true professionals that have been studying not only dock seals but also dock equipment as a whole for the past 26 years. Taking into consideration scores of factors, we'll steer you in the right direction. At the same time we will honor our promised delivery dates and provide quality materials and workmanship that is unparalleled in our industry.

We are honest and we care what happens after the sale. We always stand behind our products.

Gary and Chris Buechel



**Authorized Dealer:**